

GreenDELTA^{TC}

sustainability consulting + software

Life Cycle Costing – a Code of Practice. Key messages and critical evaluation

Andreas Ciroth, David Hunkeler, Walter Klöpffer, Tom Swarr, Hanna Pesonen,
LCA XI Chicago, October 2011

Outline

1. Background: Why „environmental LCC“, history
2. Key messages from the recent Code of Practice for Environmental LCC
3. (an attempt for a) Critical evaluation
4. What's next?

1. Environmental LCC, Background

LCC: Assessing all costs related to a product, over its entire life cycle

- Broadly used in industry
- Especially long living goods with an „interesting“ use phase
 - Railway vehicles
 - Buildings, chemical plants
 - Cars
 - ...
- First reported use worldwide in the US, DoD, in a tractor delivery contract, 1930's

Examples for LCC application in industry

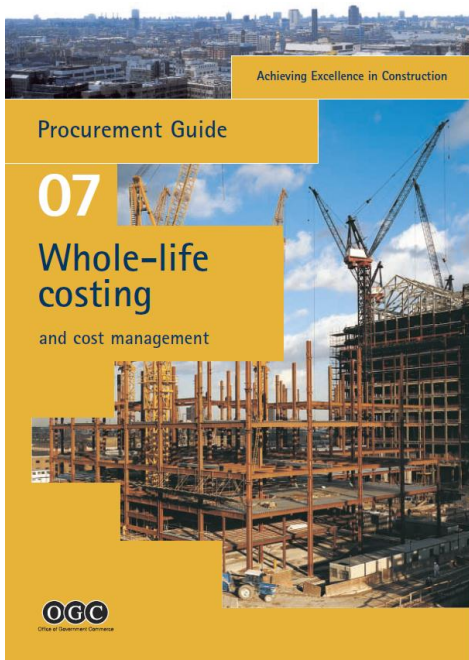

Part III:
**MEASURE ANALYSIS
and LIFE-CYCLE COST**
2005 California Building Energy Efficiency Standards

CALIFORNIA
ENERGY
COMMISSION



Contract Number
400-00-061
P400-02-013
July 3, 2002

Gray Davis, Governor



NISTIR 7025

NIST

U.S. Department of Commerce
Technology Administration
National Institute of Standards and Technology

Office of Applied Economics
Building and Fire Research Laboratory
Gaithersburg, MD 20899

**Applications of Life-Cycle Cost Analysis to
Homeland Security Issues in Constructed
Facilities: A Case Study**

Robert E. Chapman

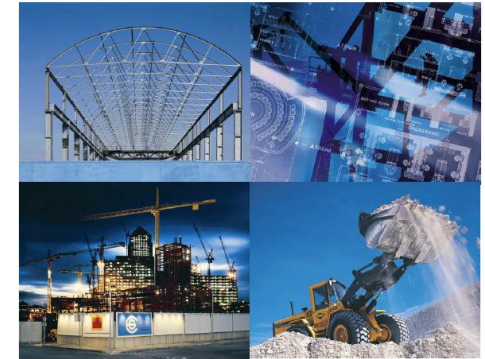

Why Environmental LCC?

- Cost information for the entire life cycle is often useful in combination with (environmental) LCA.
 - economic and environmental impact of a product
 - eco-efficiency approaches
 - ...
- There are many different ways to perform an LCC; in combination with LCA
 - avoid double-work
 - avoid double counting, overlaps, gaps
 - Environmental LCC: A method designed to be used in parallel with (environmental) LCA efficiently and consistently.

History: SETAC LCC Working Group

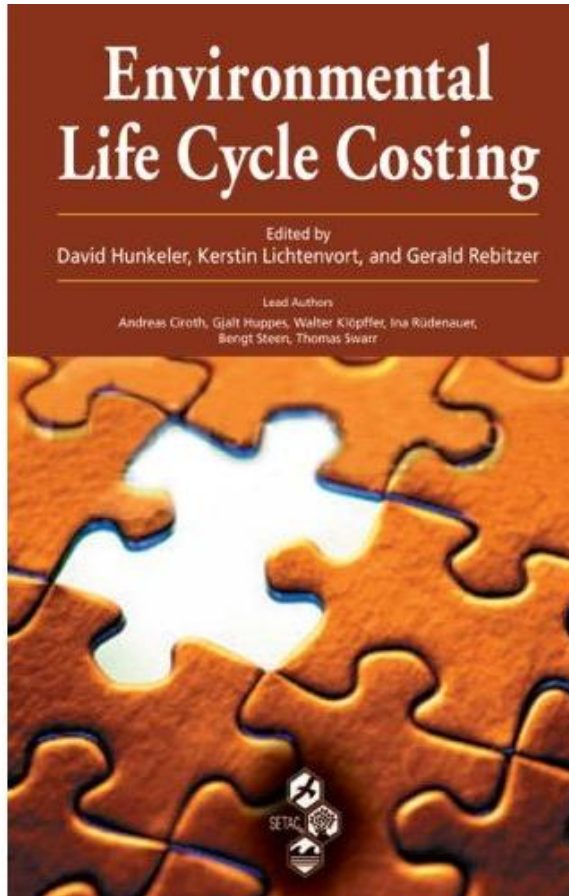

Hunkeler, D., Rebitzer, G.,
Lichtenvort, K. (edts.):
Environmental Life Cycle
Costing. Lead authors: Croth,
A.; Hunkeler, D.; Huppel, G.;
Lichtenvort, K.; Rebitzer, G.;
Rüdener, I.; Steen, B., Setac,
Taylor & Francis 2008

History: SETAC LCC Working Group

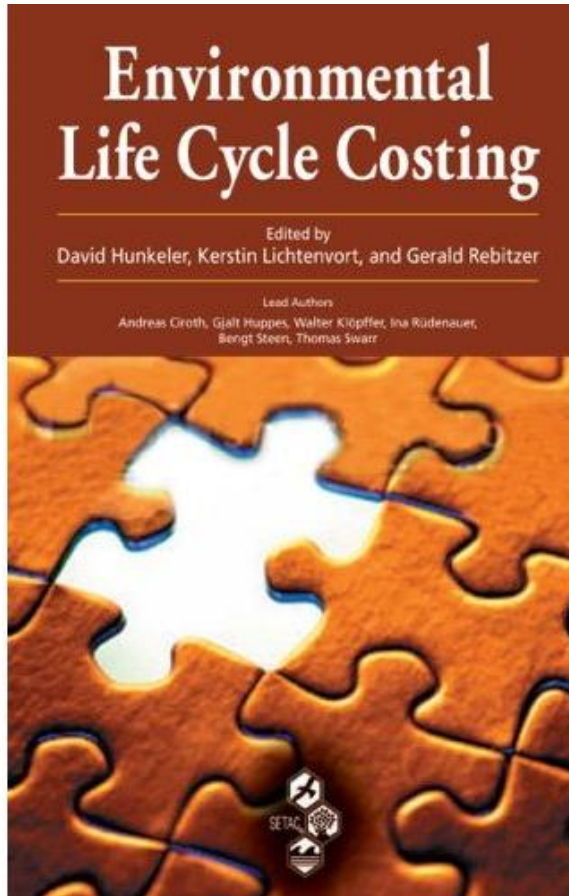

Hunkeler, D., Rebitzer, G.,
Lichtenvort, K. (edts.):
Environmental Life Cycle
Costing. Lead authors: Croth,
A.; Hunkeler, D.; Huppel, G.;
Lichtenvort, K.; Rebitzer, G.;
Rüdener, I.; Steen, B., Setac,
Taylor & Francis **2008**

Working group started 2003; first complete
version of document available 2006

History: SETAC LCC Task Force

- Aim:
 - Further condense the work of the Environmental LCC Working Group
 - Write a „Code of Practice“ similar to the SETAC LCA Code of Practice
- Members:
Tom Swarr, David Hunkeler, Walter Klöpffer, Hanna Pesonen, Andreas Ciroth, Robert Pagan, Alan Brent

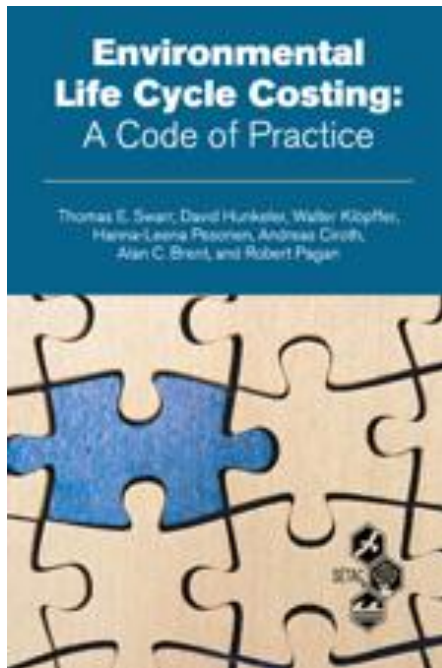

Swarr, T., Hunkeler, D., Klöpffer, W., Pesonen, H.-L.,
Ciroth, A., Brent, A. C., Pagan, R. (2011), ISBN 978-1-
880611-87-6. SETAC press.

In the US 5\$, in Europe ca. 30 € due to customs taxes (!)

2. Code of Practice for Environmental LCC: Key Messages

LCC CoP: Key Messages

- A definition for LCC, including a definition of what is assessed as cost
- LCC modeling structure parallel to an LCA
- Functional unit
- System boundary
- Time and discounting
- Allocation

→ What is Environmental LCC

Life Cycle Costing summarizes all costs associated within the life cycle of a product that are directly covered by one, or more, of the actors in the product life cycle (e.g. supplier, producer, user/consumer, End-of-Life actor).

→ What is Environmental LCC

Life Cycle Costing summarizes all costs associated within the life cycle of a product that are **directly** covered by one, or more, of the actors in the product life cycle (e.g. supplier, producer, user/consumer, End-of-Life actor).

→ What is Environmental LCC

Life Cycle Costing summarizes all costs associated within the life cycle of a product that are **directly** covered by one, or more, of the actors in the product life cycle (e.g. supplier, producer, user/consumer, End-of-Life actor).

Costs are the monetary value of goods and services that producers and consumers purchase (real money flows)

→ What is Environmental LCC

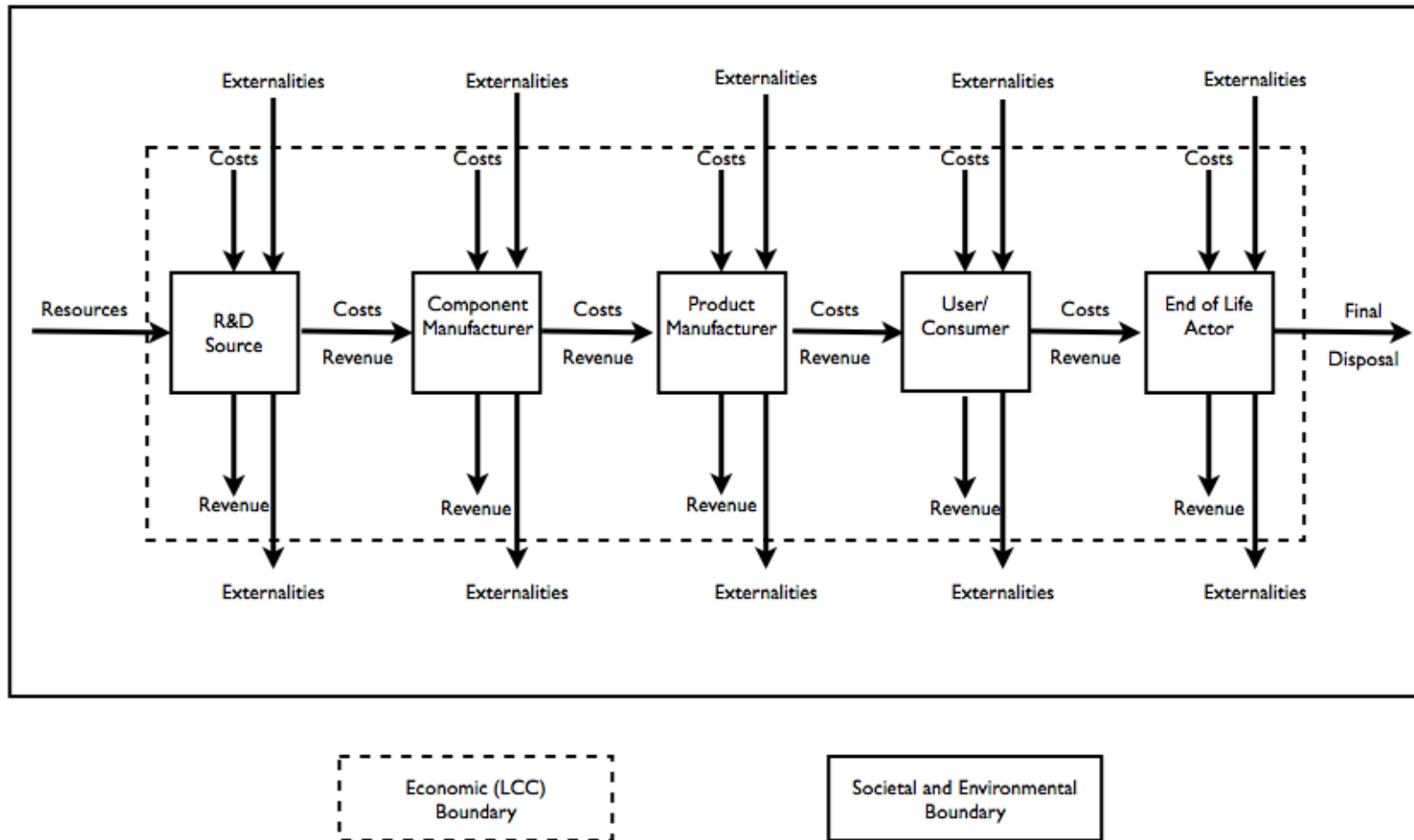

Rebitzer, G., Hunkeler, D. 2003. Life cycle costing in LCM: Ambitions, opportunities, and limitations – Discussing a framework. Editorial, International Journal of Life Cycle Assessment 8(5):253-256.

→ LCC modeling structure parallel to an LCA

ISO 14040 as reference used when writing the CoP

Also the phases are the same:

- Goal and scope
- Life Cycle inventory & impact assessment
- Interpretation

(albeit a cost inventory usually is also the cost assessment)

→ Functional unit

- Functional unit is a central concept for Environmental LCC, just as in LCA.
- For an Env. LCC, the functional unit shall be defined in a similar manner as for an LCA
- When Env. LCC is meant to be conducted in parallel to an LCA, the functional unit needs to be identical.
(otherwise, no consistent overall result)

→ System boundaries

- System boundaries need to be clearly defined and documented
- When Env. LCC is meant to be conducted in parallel to an LCA, system boundaries for both need to be equivalent.
(NOT identical!)
(e.g., R&D relevant for costs, EoL relevant for the environmental impacts)

→ Perspectives, and cost types

- An LCC reflects the perspective of one or several life cycle actors
- An LCC creates a Cost Breakdown Structure (CBS) for the product
- This CBS structures elements of the product under study, for each life cycle stage considered, in different cost types
- The cost types depend also on the perspective

→ Time, discounting

→ Time, discounting

- In (conventional) LCC, time is usually considered, especially for long-living goods
- If it is considered, then costs are usually discounted
- While in LCA, time is usually ignored

Application: $P(T) = 1/(1+r)^T$

With:

P(T): discount factor; a future cash flow multiplied with P yields the value of a present cash flow;

r: Discount rate (usually in [%])

T: Time units (usually years)

Application: $P(T) = 1/(1+r)^T$

With: $P(T)$: discount factor; a future cash flow multiplied with P yields the value of a present cash flow;

r : Discount rate (usually in [%])

T : Time units (usually years)

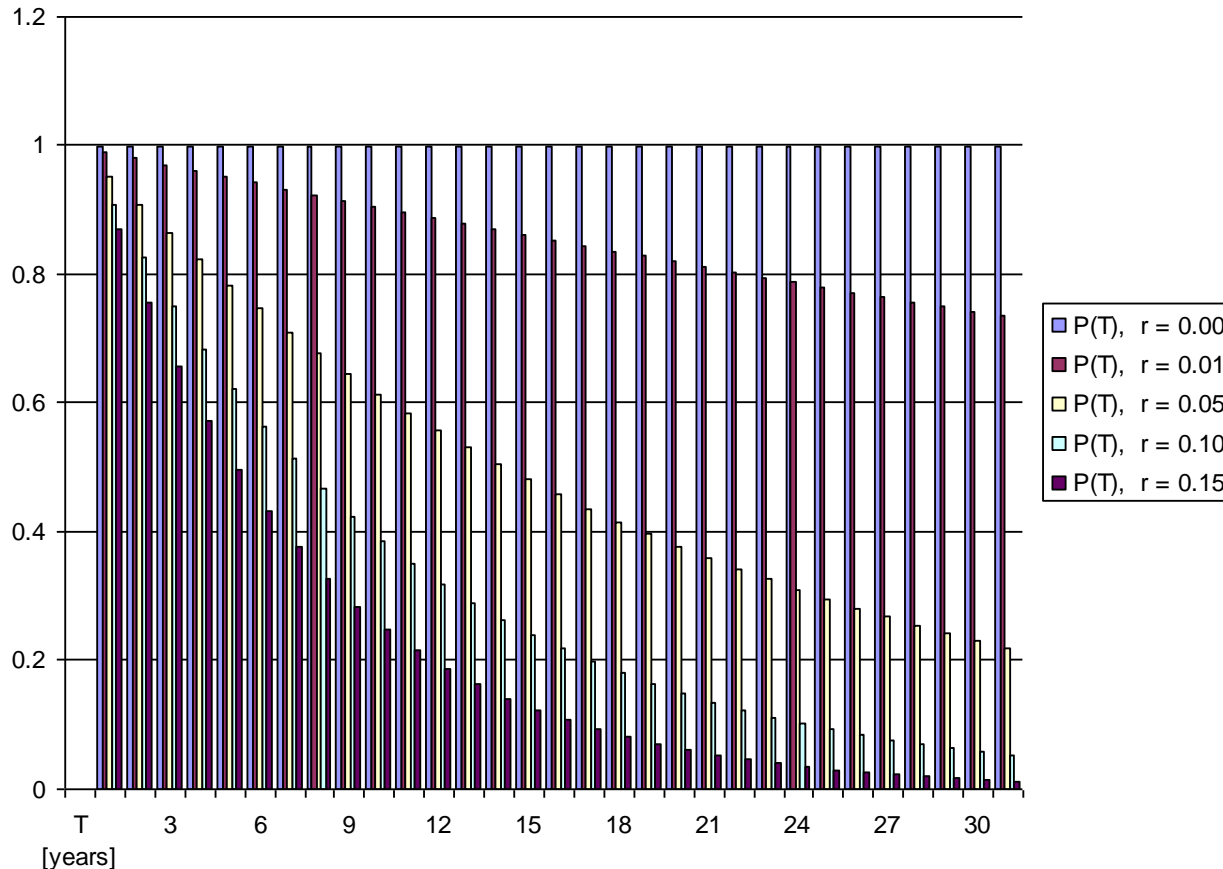

→ Time, discounting, example:

Study on German train component, to be operated 30 years

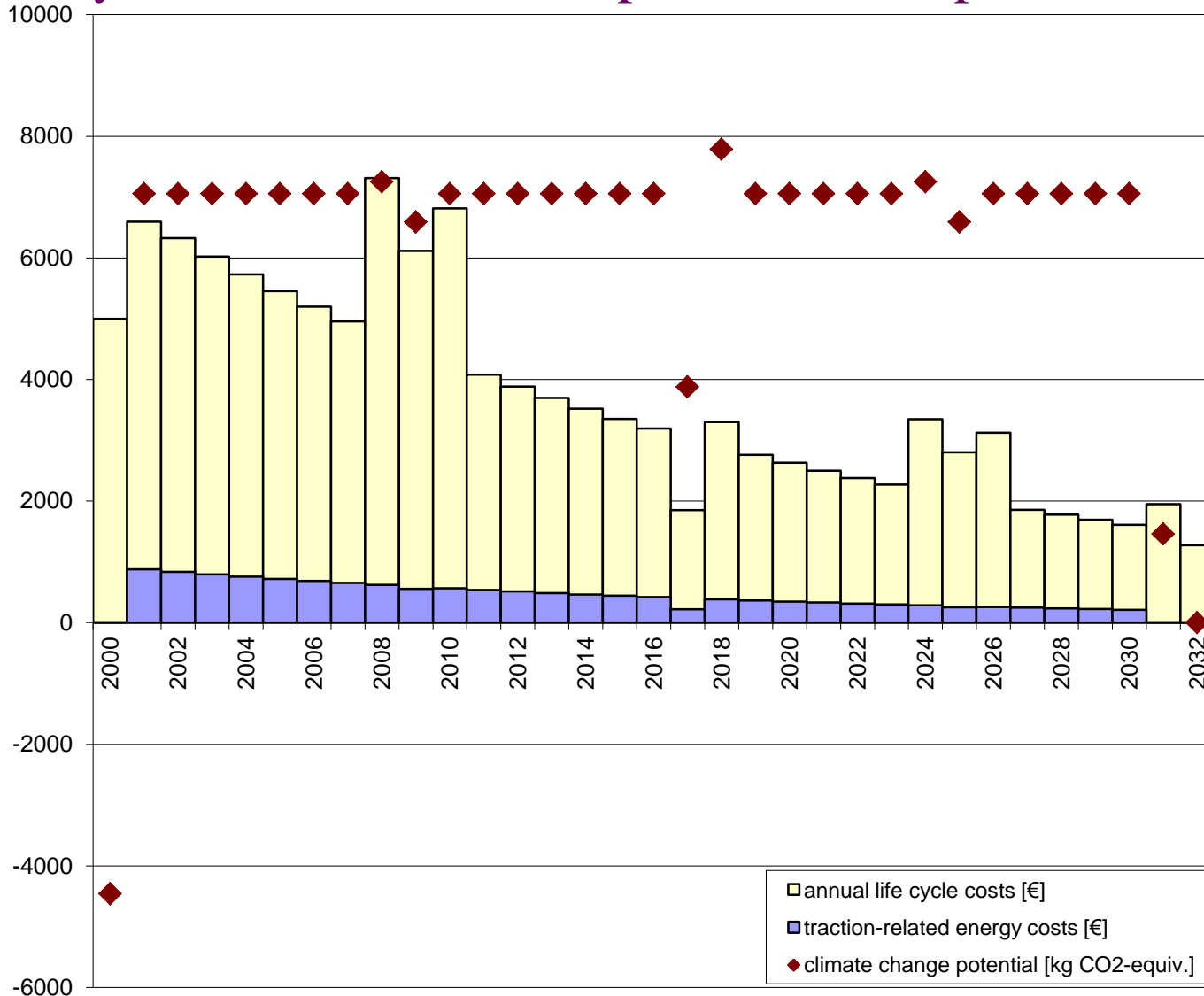

→ Allocation

- Allocation (assignment of burdens to more than one product) is a very common problem in LCC, and often decisive

CoP:

- avoid allocation;
- reduce the amount that needs to be allocated (Activity based costing instead of other cost accounting methods);
- specialty: Often no direct material flow between processes that need to be considered in allocation (insurance rate for production building)

→ Allocation

- speciality: Often no direct material flow between processes that need to be considered in allocation (insurance rate for production building)

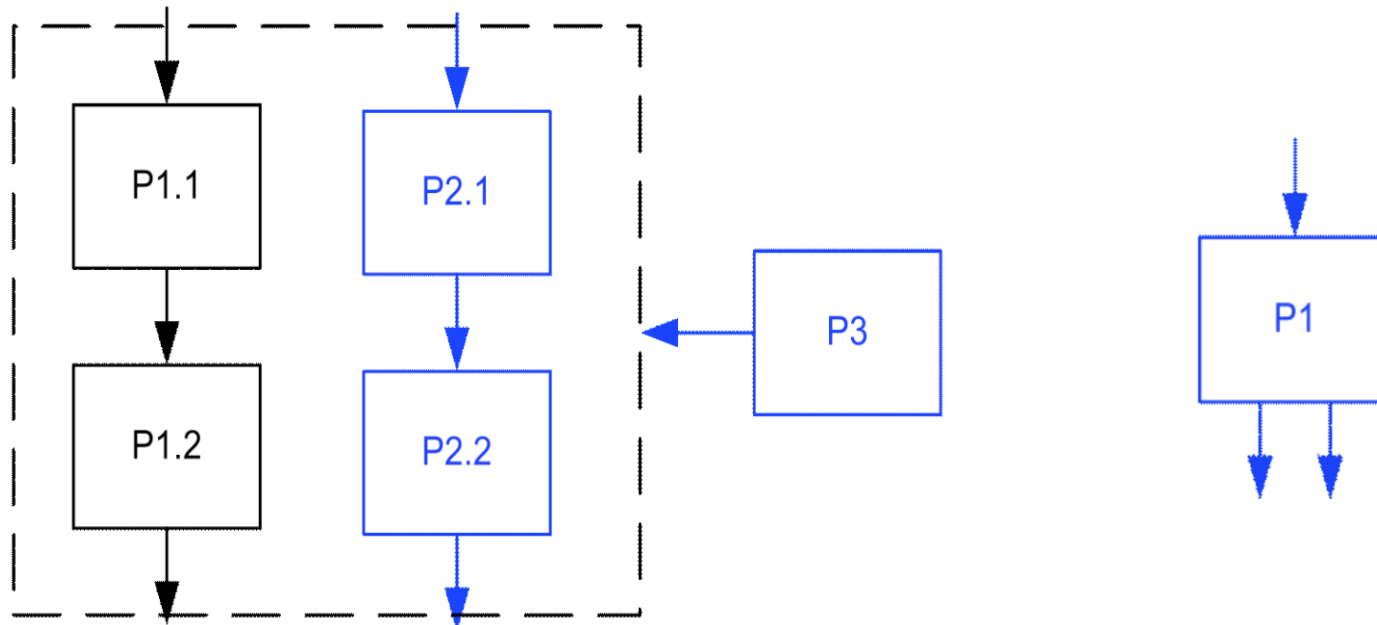

3. Attempt for a critical evaluation

CoP: Critical Evaluation, 1

- CoP proposes an LCC approach that fits to (environmental) LCA.
- This is a large step forward, and possible without „deforming“ LCC.
- It is needed since there are many LCC approaches, with often very different results when applied, and LCC is usually applied not in LCA-context
- The CoP is short and general. It tries to illustrate its points by case studies, but often does not give a final recommendation
- This is good and fully justified (we think) since the final decision needs to be flexible and fit to a specific case

CoP: Critical Evaluation, 2

However,

- Costs are not natural science figures, but perceived value.
- When applied in the context of LCA, LCC results are often too easily accepted.
- Probably more guidance is needed on how to collect data for LCC, and how to quality-assure, and review, an LCC study in the context of LCA

→ We invite everybody to apply the LCC CoP, and to report about the experiences!

4. Environmental LCC, what's next

What's next

- (some say that) the LCC Code of Practice is suitable for a standardisation
- Eco-efficiency standardisation is ongoing but almost complete; costs are one part but how to perform the cost assessment is not detailed in the draft standard → leaves room
- On the other side, more guidance on data collection and quality assurance, review for environmental LCC is needed

Many thanks.

Dr. Andreas Giroth
GreenDeltaTC GmbH Berlin
giroth@greendeltatc.com

www.greendeltatc.com